

Air-Actuated Minidisc® Valves

At TMG Holland, we offer our Minidisc® LUD7 series of disc shut-off valves in a variety of configurations for applications that require clean or sanitary processing. The flexible design allows the Minidisc® to be used with liquids, powders, slurries and in aggressive environments. Originally designed for use in dairy tanks, the Minidisc® is manufactured from grade 316 stainless steel and meets the requirements of 3-A Sanitary Standards

Main features

- Actuator easily mounts in seconds with 1 bolt
- For product side only 3 wear parts, 1 Seat and 2 O-rings
- Two leak detector holes on stem alert operator to worn O-rings
- 3-A Sanitary Standards
- Easy-to-read Open/Close label

Industry for use Dairy, Food and Beverage

Connections Any combination of clamp, weld or thread ends are available

Operation modes

- Air to Open / Spring to Close (fail-safe)
- Spring to Open / Air to Close
- Air to Open / Air to Close

Options

- Service kits available in any combination
- Safety feedback unit with Stainless steel housing, available with solenoid
- Electronic safety feedback unit with easily self-calibrate function, available with solenoid
- Electronic controller with continuously compare the current valve position

Materials

- Product contact parts grade 316 stainless steel
- Seat material options; Silicone, EPDM, Buna, Viton, PTFE
- O-ring material options; Silicone, EPDM Buna, Viton

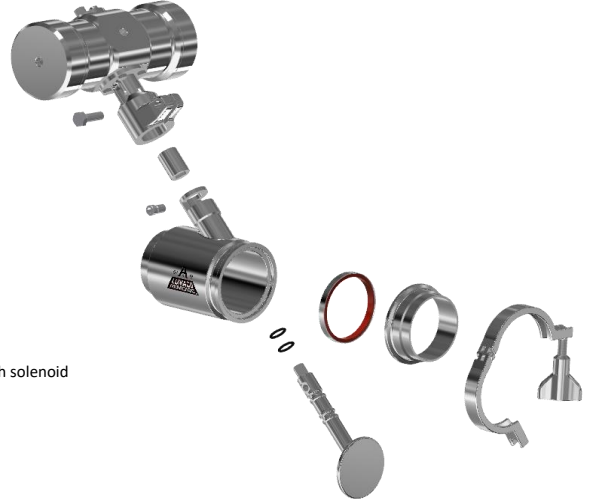

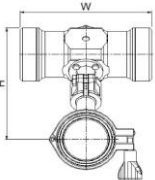
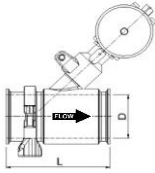

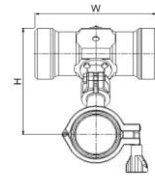
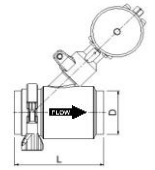

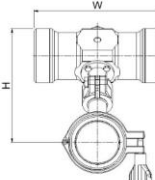
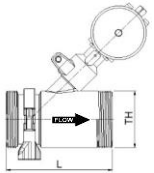
3-A Air to Air operated minidisc® valve LUD7 - Clamp / Clamp			Size	Basic Part number	L	H	W	Inside	D	Max. Working Pressure Bar / Psi
  		1,5"	MS-112-FF	111	145	169	35		6 / 090	
		2"	MS-002-FF	111	150	169	48		6 / 090	
		2,5"	MS-212-FF	131	155	169	60		6 / 090	
		3"	MS-003-FF	136	170	169	73		5 / 80	
		4"	MS-004-FF	156	187	169	98		5 / 80	
		6"	MS-006-FF	181	282	413	147		5 / 80	

3-A Air to Air operated minidisc® valve LUD7 - Weld / Weld			Size	Basic Part number	L	H	W	D	Max. Working Pressure Bar / Psi
  		1,5"	MS-112-AA	105	145	169	39 x 2		6 / 090
		2"	MS-002-AA	105	150	169	52 x 2		6 / 090
		2,5"	MS-212-AA	125	155	169	64 x 2		6 / 090
		3"	MS-003-AA	130	170	169	77 x 2		5 / 80
		4"	MS-004-AA	150	187	169	102 x 2		5 / 80
		6"	MS-006-A3A3	181	282	413	152,4 x 2,7		5 / 80

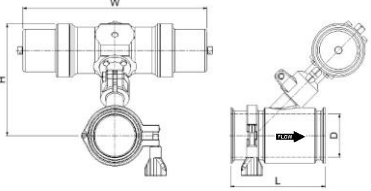
3-A Air to Air operated minidisc® valve LUD7 - Thread / Thread			Size	Basic Part number	L	H	W	D	Max. Working Pressure Bar / Psi
  		1,5"	MS-112-RR	121	145	169	50,65ACME8TPI		6 / 090
		2"	MS-002-RR	121	150	169	64,16ACME8TPI		6 / 090
		2,5"	MS-212-RR	141	155	169	77,67ACME8TPI		6 / 090
		3"	MS-003-RR	146	170	169	91,19ACME8TPI		5 / 80
		4"	MS-004-RR	166	187	169	119,24ACME8TPI		5 / 80

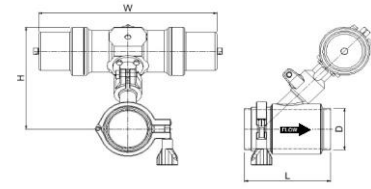
Air-Actuated Minidisc® Valves

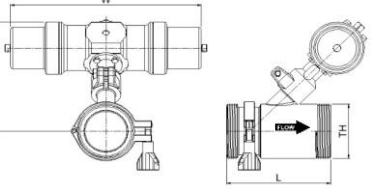
3-A Air to Spring operated minidisc® valve LUD7 - Clamp / Clamp		Size	Basic Part number	L	H	W	D	Max. Working Pressure Bar / Psi
 	2"	MS-002-FF	111	150	258	48	8 / 120	
	2,5"	MS-212-FF	131	155	258	60	8 / 120	
	3"	MS-003-FF	136	170	258	73	5 / 80	
	4"	MS-004-FF	156	187	330	98	5 / 80	
	6"	MS-006-FF	181	282	555	147	5 / 80	
3-A Air to Spring operated minidisc® valve LUD7 - Weld / Weld		Size	Basic Part number	L	H	W	D	Max. Working Pressure Bar / Psi
 	2"	MS-002-AA	105	150	258	52 x 2	8 / 120	
	2,5"	MS-212-AA	125	155	258	64 x 2	8 / 120	
	3"	MS-003-AA	130	170	258	77 x 2	5 / 80	
	4"	MS-004-AA	150	187	330	102 x 2	5 / 80	
	6"	MS-006-AA	181	282	555	152,4 x 2,7	5 / 80	
3-A Air to Spring operated minidisc® valve LUD7 - Thread / Thread		Size	Basic Part number	L	H	W	D	Max. Working Pressure Bar / Psi
 	2"	MS-002-RR	121	150	258	64,16ACME8TPI	8 / 120	
	2,5"	MS-212-RR	141	155	258	77,67ACME8TPI	8 / 120	
	3"	MS-003-RR	146	170	258	91,19ACME8TPI	5 / 80	
	4"	MS-004-RR	166	187	330	119,24ACME8TPI	5 / 80	